



8 Amps, 500 Volts N-CHANNEL POWER MOSFET

■ DESCRIPTION

The YR IRF840 are N-Channel enhancement mode power field effect transistors (MOSFET) which are produced using YR's proprietary, planar stripe, DMOS technology.

These devices are suited for high efficiency switch mode power supply. To minimize on-state resistance, provide superior switching performance, and withstand high energy pulse in the avalanche and commutation mode the advanced technology has been especially tailored.

■ FEATURES

- * $R_{DS(ON)} = 0.85\Omega @ V_{GS} = 10V$
- * Ultra low gate charge (typical 42 nC)
- * Low reverse transfer capacitance ($C_{RSS} =$ typical 25 pF)
- * Fast switching capability
- * Avalanche energy specified
- * Improved dv/dt capability, high ruggedness

■ SYMBOL

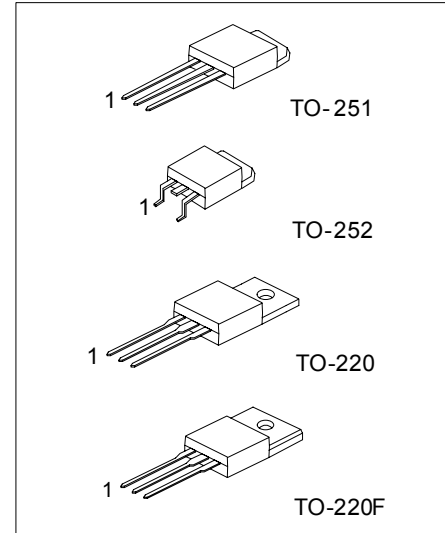
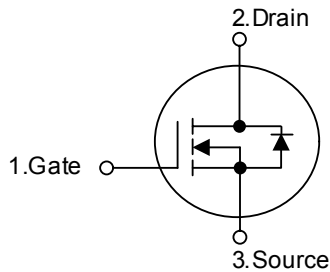

*Pb-free plating product number: IRF840

■ ABSOLUTE MAXIMUM RATINGS

Symbol	Parameter	Rating	Units
V_{DS}	Drain-Source Voltage	500	V
V_{GS}	Gate-Source Voltage	± 20	V
$I_D@T_C=25^\circ C$	Continuous Drain Current, $V_{GS} @ 10V$	8	A
$I_D@T_C=100^\circ C$	Continuous Drain Current, $V_{GS} @ 10V$	5.1	A
I_{DM}	Pulsed Drain Current ¹	32	A
$P_D@T_C=25^\circ C$	Total Power Dissipation	125	W
	Linear Derating Factor	1	W/ $^\circ C$
E_{AS}	Single Pulse Avalanche Energy ²	320	mJ
I_{AR}	Avalanche Current	8	A
T_{STG}	Storage Temperature Range	-55 to 150	$^\circ C$
T_J	Operating Junction Temperature Range	-55 to 150	$^\circ C$

■ THERMAL DATA

Symbol	Parameter	Value	Unit
Rthj-c	Thermal Resistance Junction-case	Max. 1.0	$^\circ C/W$
Rthj-a	Thermal Resistance Junction-ambient	Max. 62	$^\circ C/W$

■ ELECTRICAL CHARACTERISTICS $T_C = 25$ unless otherwise specified

Symbol	Parameter	Test Conditions	Min.	Typ.	Max.	Units
BV_{DSS}	Drain-Source Breakdown Voltage	$V_{GS}=0V, I_D=1mA$	500	-	-	V
$R_{DS(ON)}$	Static Drain-Source On-Resistance	$V_{GS}=10V, I_D=4.8A$	-	-	0.85	Ω
$V_{GS(th)}$	Gate Threshold Voltage	$V_{DS}=V_{GS}, I_D=250\mu A$	2	-	4	V
g_{fs}	Forward Transconductance	$V_{DS}=10V, I_D=4.8A$	-	4.2	-	S
I_{DSS}	Drain-Source Leakage Current ($T_J=25^\circ C$)	$V_{DS}=500V, V_{GS}=0V$	-	-	25	μA
	Drain-Source Leakage Current ($T_J=125^\circ C$)	$V_{DS}=400V, V_{GS}=0V$	-	-	250	μA
I_{GSS}	Gate-Source Leakage	$V_{GS}=\pm 20V$	-	-	± 100	nA
Q_g	Total Gate Charge ³	$I_D=8A$	-	45	72	nC
Q_{gs}	Gate-Source Charge	$V_{DS}=400V$	-	7	-	nC
Q_{gd}	Gate-Drain ("Miller") Charge	$V_{GS}=10V$	-	25	-	nC
$t_{d(on)}$	Turn-on Delay Time ³	$V_{DD}=250V$	-	12	-	ns
t_r	Rise Time	$I_D=8A$	-	31	-	ns
$t_{d(off)}$	Turn-off Delay Time	$R_G=9.1\Omega, V_{GS}=10V$	-	48	-	ns
t_f	Fall Time	$R_D=31\Omega$	-	33	-	ns
C_{iss}	Input Capacitance	$V_{GS}=0V$	-	1250	2000	pF
C_{oss}	Output Capacitance	$V_{DS}=25V$	-	270	-	pF
C_{rss}	Reverse Transfer Capacitance	$f=1.0MHz$	-	85	-	pF
R_g	Gate Resistance	$f=1.0MHz$	-	1.6	2.4	Ω

 ■ ELECTRICAL CHARACTERISTICS(Cont.)

Symbol	Parameter	Test Conditions	Min.	Typ.	Max.	Units
V_{SD}	Forward On Voltage ³	$T_j=25^{\circ}\text{C}$, $I_S=8\text{A}$, $V_{GS}=0\text{V}$	-	-	1.5	V
t_{rr}	Reverse Recovery Time ³	$I_S=8\text{A}$, $V_{GS}=0\text{V}$, $di/dt=100\text{A}/\mu\text{s}$	-	515	-	ns
Q_{rr}	Reverse Recovery Charge		-	8.6	-	μC

Notes:

- 1.Pulse width limited by Max. junction temperature.
- 2.Starting $T_j=25^{\circ}\text{C}$, $V_{DD}=50\text{V}$, $L=10\text{mH}$, $R_G=25\Omega$
- 3.Pulse test

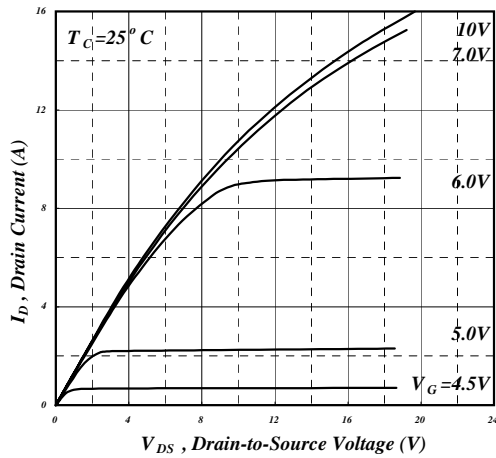

Fig 1. Typical Output Characteristics

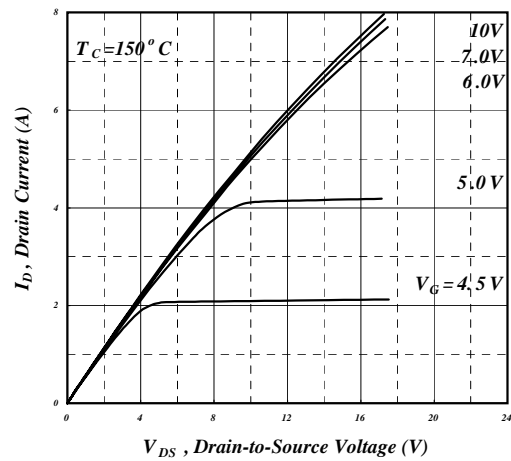

Fig 2. Typical Output Characteristics

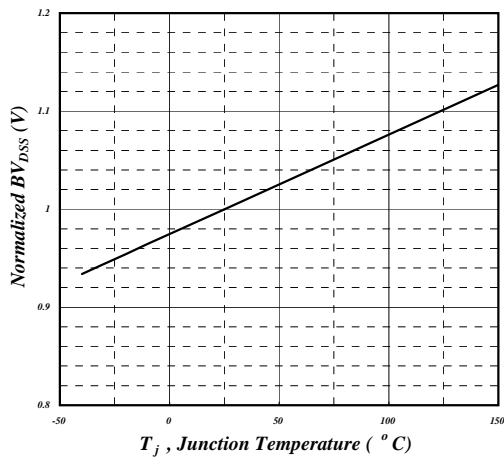

Fig 3. Normalized BV_{DSS} v.s. Junction Temperature

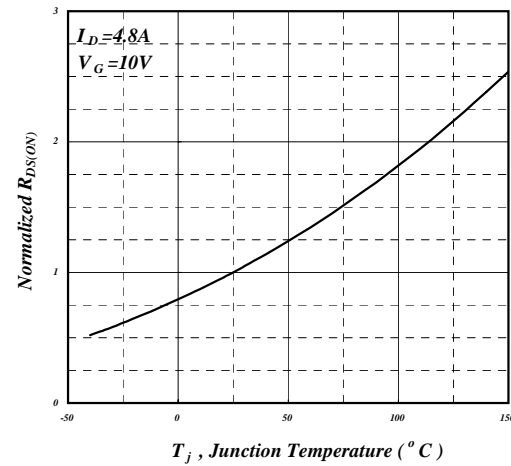

Fig 4. Normalized On-Resistance v.s. Junction Temperature

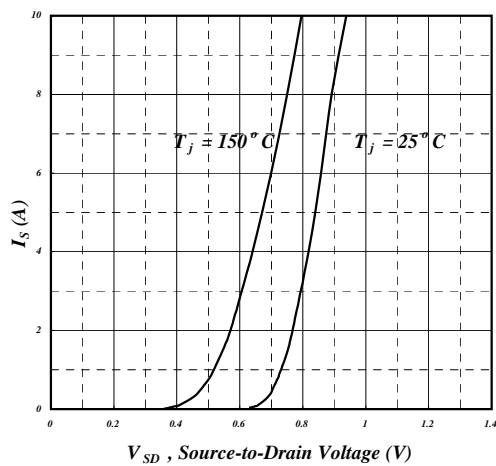

Fig 5. Forward Characteristic of Reverse Diode

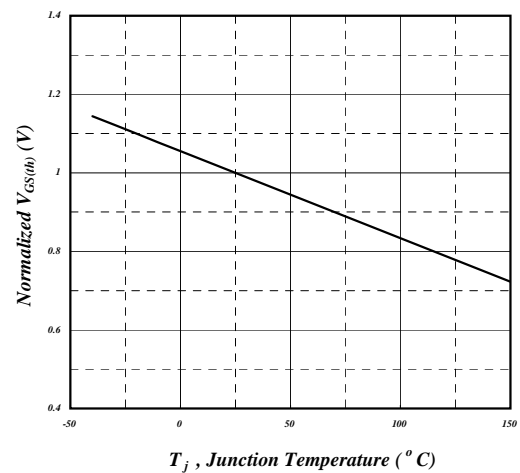

Fig 6. Gate Threshold Voltage v.s. Junction Temperature

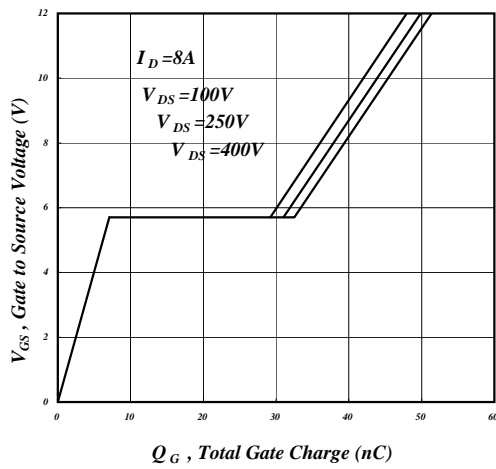

Fig 7. Gate Charge Characteristics

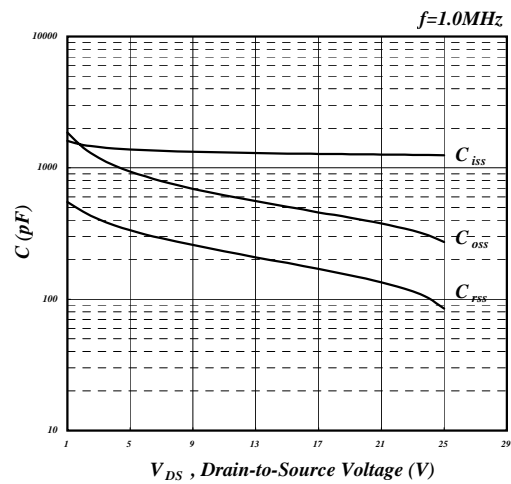

Fig 8. Typical Capacitance Characteristics

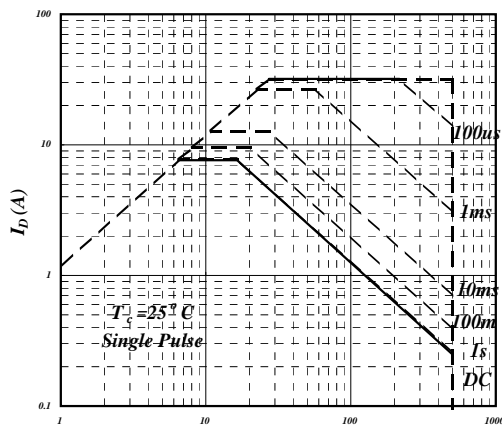

Fig 9. Maximum Safe Operating Area

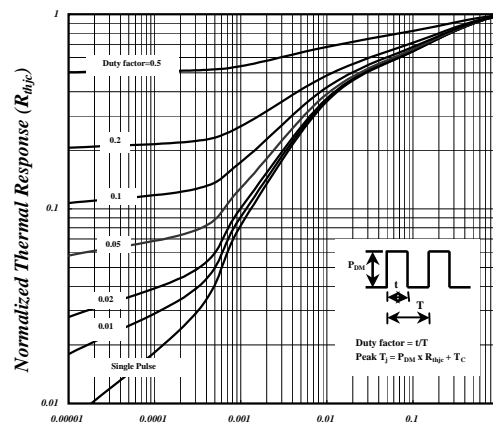

Fig 10. Effective Transient Thermal Impedance

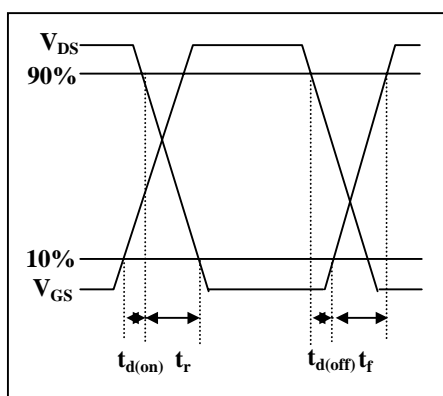

Fig 11. Switching Time Waveform

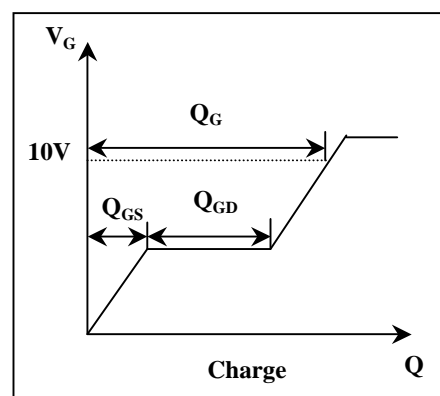

Fig 12. Gate Charge Waveform